

ION6200 Remote Modular Display

The PowerLogic® ION6200 Remote Modular Display (RMD) is available as an option for ION6200 TRAN meters.

In This Document

◆ Mounting the RMD	2
Location & Mounting	2
RMD Dimensions	2
Mounting the RMD in a DIN or ANSI Cutout	2
Mounting the RMD on a Flat Panel	3
◆ Connecting the Remote Modular Display	4

Electrical equipment should be installed, operated, serviced, and maintained only by qualified personnel. No responsibility is assumed by Schneider Electric for any consequences arising out of the use of this material.

© 2006 Schneider Electric.
All rights reserved.
www.powerlogic.com

Mounting the RMD

⚠ DANGER

Installation and maintenance of ION meters and meter options should only be performed by qualified personnel that have appropriate training and experience with high voltage/current devices. Refer to Installation Considerations, and the Danger, Warning, and Limitation of Liability notices in the *ION6200 Installation and Operation Guide*.

Location & Mounting

The RMD should be mounted in a dry location free from dirt and corrosive vapors. Once installed, no cleaning of the device is necessary. When the RMD unit is mounted flush to a panel, the front side meets type 4, 4x and 5 of NEMA standards 1-10-1979 and 5-25-1988.

RMD Dimensions

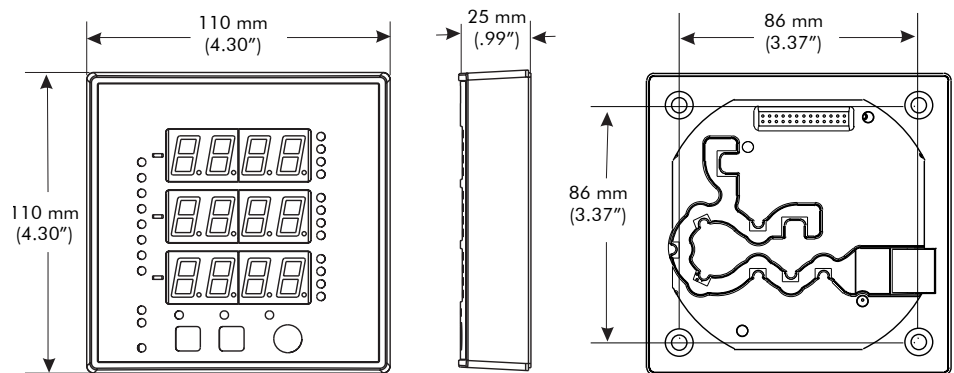

Mounting the RMD in a DIN or ANSI Cutout

The RMD can be mounted in either a standard ANSI 4" or DIN 96 cutout.

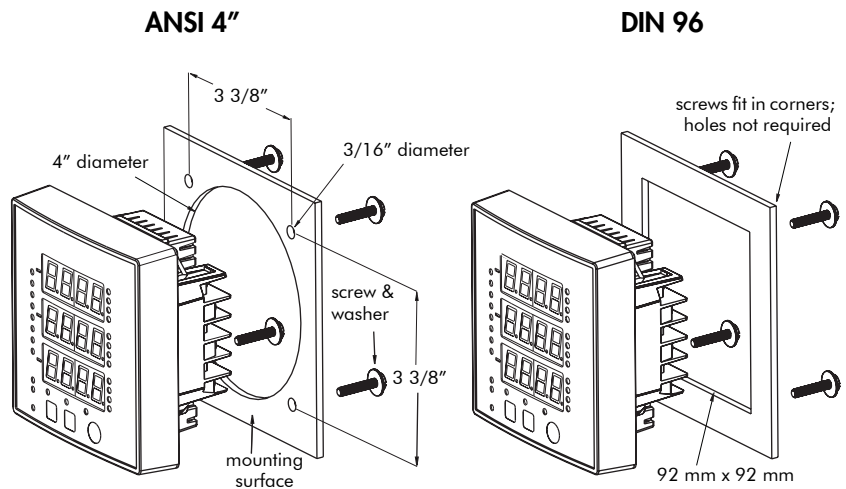

To mount the RMD in an ANSI or DIN cutout:

1. Fit the RMD into the cutout [DIN 96 standard or ANSI 4"].
2. Insert each screw through the drilled hole on the mounting surface and into its corresponding metal insert located on the back of the RMD. Note that the DIN 96 cutout does not require drilled holes.
3. Tighten screws using a #2 Phillips screwdriver. Do not overtighten.

Mounting the RMD on a Flat Panel

The RMD can be mounted on a flat panel. The hole pattern required to mount the RMD to a flat panel is shown in actual size on the diagram below, which can be used as a template.

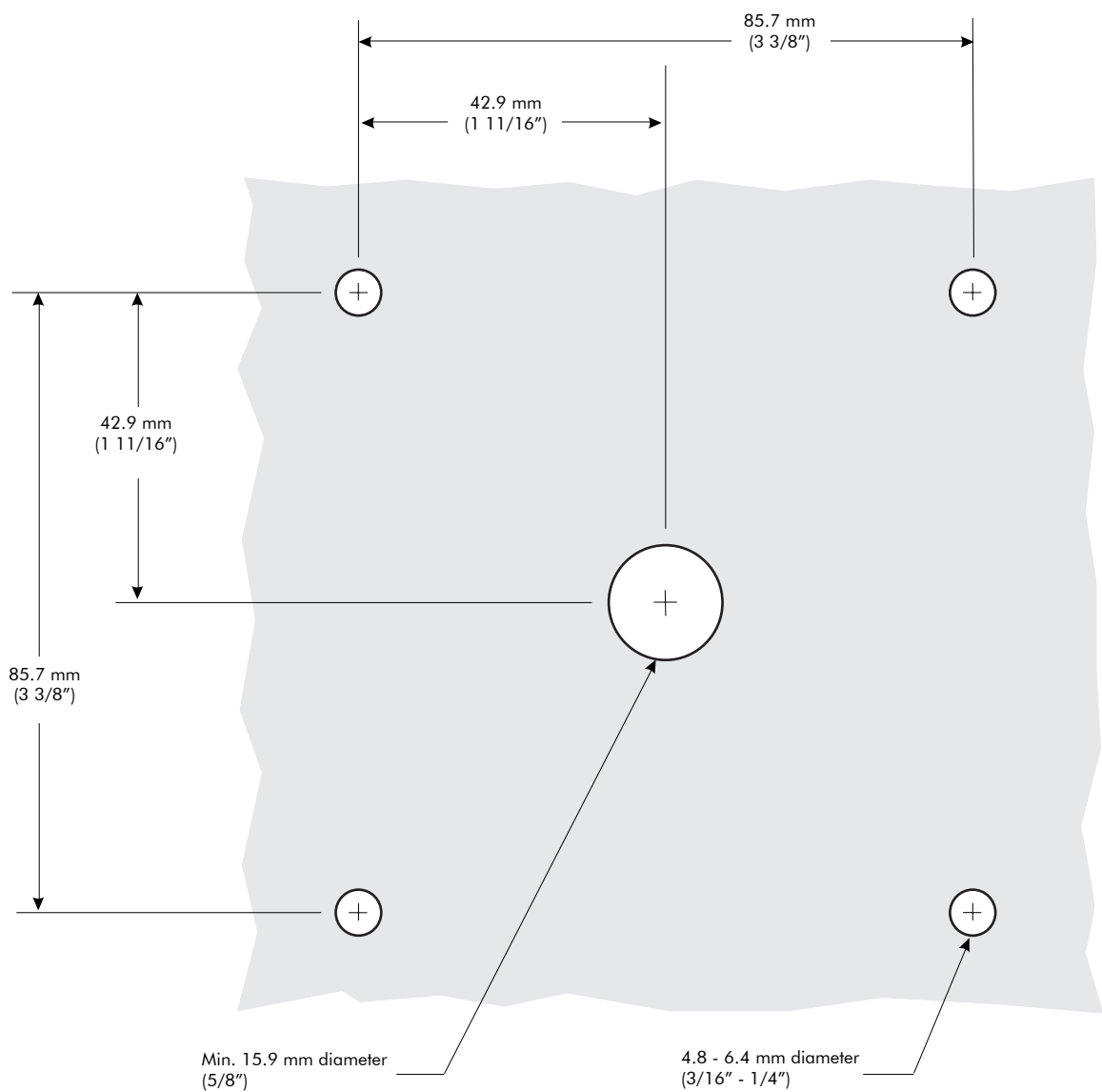

Connecting the Remote Modular Display

Connect the RMD to the TRAN with the supplied 26 gauge 6 conductor RJ11-type cable. The cable connects between the RJ11 socket on the backside of the RMD, and the RJ11 socket on the side of the TRAN.

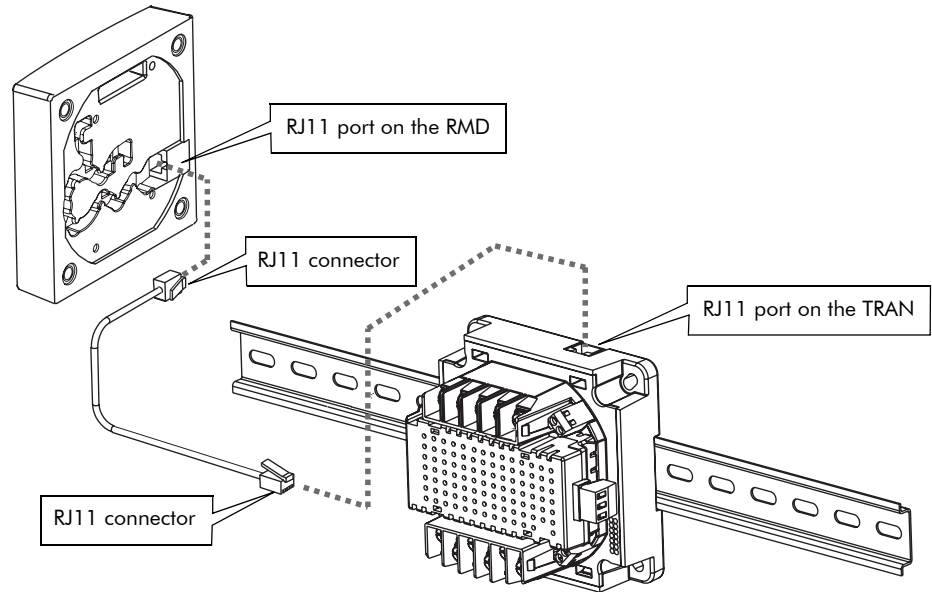

To connect the RMD and the TRAN meter:

1. Slide the RJ11 connector into the RJ11 port at the back of the RMD (the RJ11 connector locking tab faces outwards).
2. Thread the free end of the cable through the recessed channel.

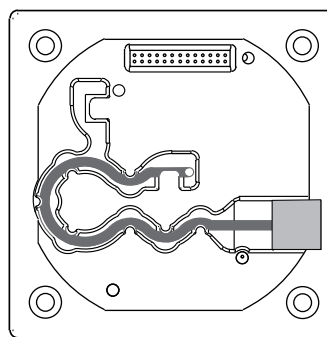

Cable Path

3. Take the free end of the cable and insert its RJ11 connector into the RJ11 port on the side of the TRAN (the RJ11 connector locking tab faces outwards).