

INSTALLATION NOTES

Applicable for the following catalog numbers*:

45-MC5600VXCL10 12C (CDN 1EL/12M600DTA3P3W)

*These instructions are also applicable when the same meter model number has the suffix: -E, -P or EP.

CRITICAL: The installation of the current transformer must be correct or the meter will not read properly. The load-current carrying wires must pass through the CT in the correct orientation, and the CT wires must be connected to the proper MCI screw terminals. Please see wiring diagram for reference.

Current transformers (CTs) are used to measure the current drawn by the loads to be metered. Within the meter, the current reading from the CT is combined with the voltage reading for the correct voltage phase to calculate the energy reading. CTs must be in phase with the reference voltage. The MCI inputs are each associated with a particular voltage phase in an A-C order. Input 1 is a phase A CT, input 2 is a phase C CT, input 3 is a phase A CT, input 4 is a phase C CT, and so on in A-C-A-C order.

For example, a CT which measures a load supplied by phase A must be installed on CT1, CT3, CT5, etc.. Current transformers which measure a load supplied by phase C must be installed on CT2, CT4, CT6, etc..

1. For the catalog numbers specified above, each A-C combination is a single meter point (see Table 1 for full listing):

- Meter #1 (M#1) is CT1 and CT2
- Meter #2 (M#2) is CT3 and CT4
- repeat for M#3 to M#12

2. After completing all CT terminations, connect the four (4) current connectors and then remove the the twenty-four (24) shorting links.

3. Follow local codes for installation requirement, e.g. conduit, fused disconnect, distance, and wiring.

4. Installation of 0.1A inputs and CL10 or 5A inputs are the same.



CAUTION: If breakers are energized, shorting links must be installed before:

- a) disconnecting the CT headers or
- b) replacing or installing meter heads on the panel.

WARNING: Bodily injury or damage may result if shorting links are not installed.

Meter # (M#)	MCI Board CT #	Reference Voltage Phase
1	1	A
	2	C
2	3	A
	4	C
3	5	A
	6	C
4	7	A
	8	C
5	9	A
	10	C
6	11	A
	12	C
7	13	A
	14	C
8	15	A
	16	C
9	17	A
	18	C
10	19	A
	20	C
11	21	A
	22	C
12	23	A
	24	C

Table 1. Phase Association Table

  Quadlogic Controls Corporation		TITLE	
SIGNATURE'S		DATE	
MODEL	JREA	04/01/07	3-PHASE, 3-WIRE 3EL DELTA WIRING DIAGRAM 
APPROVED	JKIM	04/24/07	
APPROVED			SIZE DRAWING 17-MC53P3WDTACDN1.6R SCALE:
			REV 1.6.R SHEET 1 of 3

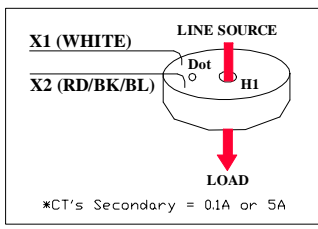
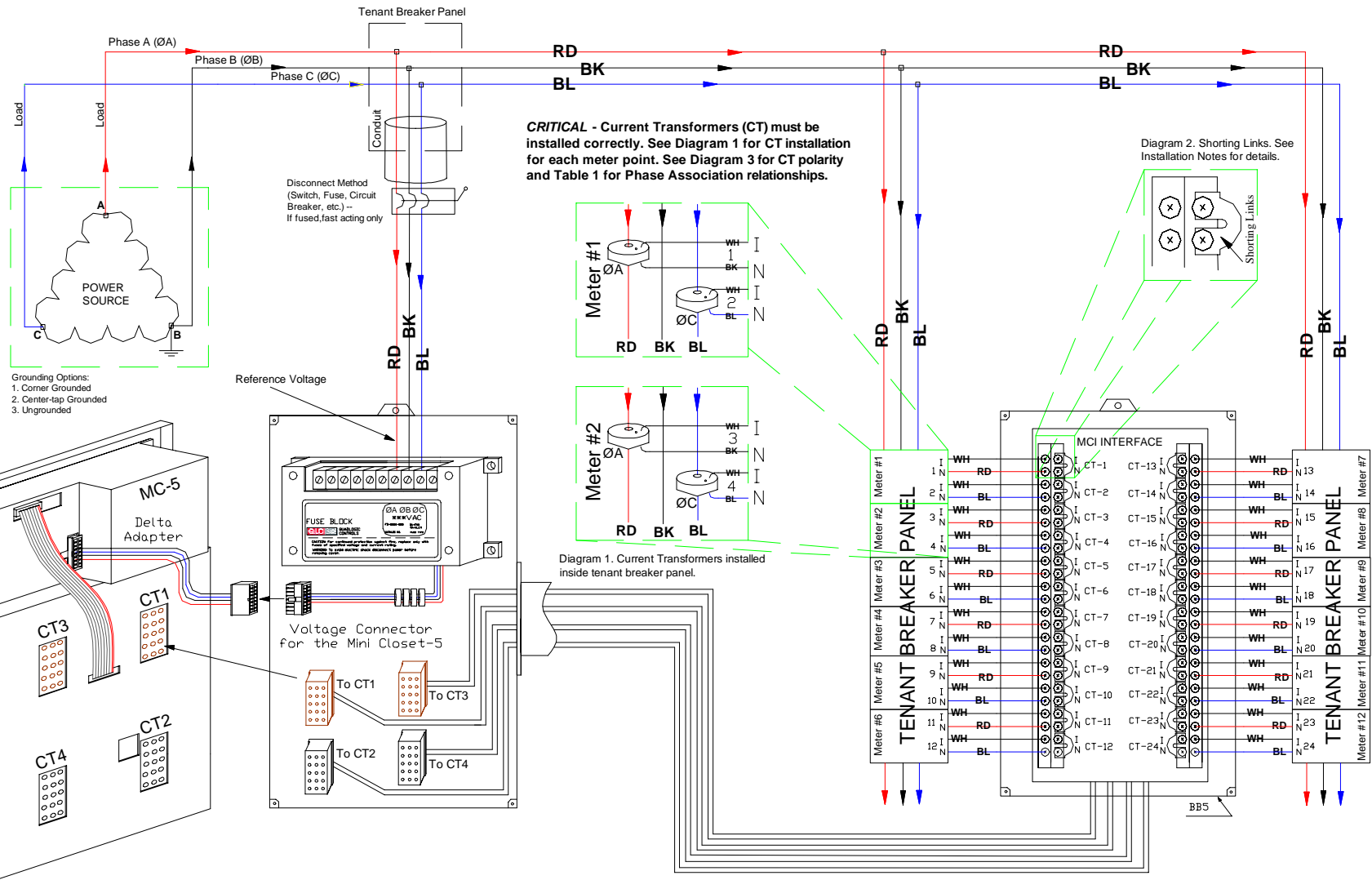

Diagram 3. CT Phasing. Dot or H1 should point towards the line or source.

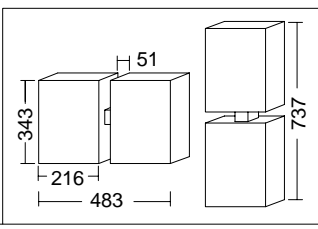

Diagram 4. Typical box orientation and dimensions (in mm).

QUAD LOGIC Quadlogic Controls Corporation	
SIGNATURES	DATE
MODEL	JREA 04/01/07
APPROVED	JKIM 04/24/07
APPROVED	

TITLE		
3-PHASE, 3-WIRE 3EL DELTA WIRING DIAGRAM		
SIZE	DRAWING	REV
	17-MC53P3WDTACDN1.6R	1.6.R
SCALE:		SHEET 2 of 3

BEFORE READING THE DISPLAY FOR ANY MC5 PRODUCT

CAUTION: When reading the meter display, all consumption and demand values must be multiplied by the correct multiplier to calculate true value. This includes all register values (kWh, kW, kVARHLg, kVARHLd, etc.) and Phase Diagnostic values (real time Amps, Watts, etc.).

Volts, phase angle, frequency and power factor are displayed on the LCD as their true values and should not be multiplied.

The multiplier value is dependent upon the ratio of the external Current Transformers (CTs) and can be different for different meter points. Please consult Table 1 CT Multipliers for the appropriate value dependent upon the rating (or size) of the CT.

HOW CT MULTIPLIERS ARE CALCULATED:

0.1AMP CTs

The multiplier values for CTs with 0.1A secondary ratings are derived by dividing the primary side rating by 100. For example, a 50:0.1A-rated CT will have a multiplier of $50 \div 100$, which is 0.50. A 100:0.1A rated CT will have a multiplier of $100 \div 100$ which is 1.)

5AMP CTs

For CTs with 5A secondary ratings, the multipliers are derived by dividing the primary side rating by 5. For example, a 200:5A-rated CT will have a multiplier of $200 \div 5$, which is 40.

EXAMPLE:

Meter point with 400:0.1A CT
LCD reading for meter is 3422.119kWh

The correct cumulative consumption (kWh) for this meter is **13688.476** kWh.
($400 \div 100 = 4$. Multiply face value for consumption and demand values by 4. $3422.119 \times 4 = 13688.476$)

NOTE: Failure to use the appropriate multiplier will result in an incorrect diagnosis of the meter's functionality and incorrect revenue billing.



Meter Voltage Ratings	CT Rating	Multiplier for 5.0A CT
FOR 120V, 208V, 277V, 347V, 480V, 600V	200A	x40.0
	400A	x80.0
	600A	x120.0
	800A	x160.0
	1200A	x240.0
	1500A	x300.0
	1600A	x320.0
	2000A	x400.0
	3000A	x600.0
	3200A	x640.0
4000A	x800.0	

FOR 240V	100A	x20.0
	200A	x40.0

Note: Contact Quadlogic for 0.1A CT multipliers.

Table 1. CT Multipliers

REVISIONS			
REV.	DESCRIPTION	DATE	APPROVED

 Quadlogic Controls Corporation		TITLE	
SIGNATURES		DATE	
MODEL	JREA	04/01/07	
DETAIL			
APPROVED	JKIM	04/24/07	
APPROVED			
3-PHASE, 3-WIRE 3EL DELTA WIRING DIAGRAM 		SIZE	DRAWING
		17-MC53P3WDTACDN1.6R	
		SCALE:	REV 1.6.R
		SHEET 3 of 3	