



Total Lighting Controls



## 48-Relay Remote Control Panel Interior



### DESCRIPTION

The RINTER0048RC is the interior for a 48-relay TLC Remote Control Panel. The interior provides isolation between the line- and low-voltage sections of the panel, as well as the mounting frame for relays, the power supply and control devices. A complete assembly will include the following:

1. Tub (RTUB48)
2. Interior (RINTER0048RC)
3. Power Supply (RPWRxxx)
4. Cover (RCOV48xxx)
5. Relays (RR7P or RR9P)

The tub/interior configuration simplifies installation. The tub can be mounted first, to allow easy access for pulling wires. The interior, with power supply and relays, then simply slides into the tub.

### FEATURES

- Up to forty-eight RR7P or RR9P plug-in relays.
- Two color-coded, numbered switch or sensor terminations per relay.
- Mounting holes for up to four RMS8, RMS16 or RPCON, or two RMS32 control devices.
- Accessory power for up to twelve occupancy sensors.

Before starting, read the installation instructions inside. If you have questions, call GE TLC Service at:

1-877-LTG-CNTL (584-2685) in the United States or  
1-800-661-6619 in Canada.

*CAUTION: Make sure all power is OFF before wiring. Do not energize wiring until the unit is fully assembled. Conform to all applicable codes.*

**INSTALLATION**

*Environment*

- 32-131°F (0-50°C)
- 95% relative humidity
- 15 volts/foot, 10 KHz maximum RFI

*Relays (RR7P or RR9P)*

Remove only as many knockouts as required. From the line-voltage side, feed the low-voltage relay connector and leads through the hole and plug the connector to the appropriate relay termination on the interconnect board. Push the relay into the hole so the retainers hold it in position. See the photo.

*Power Supply (RPWRxxx)*

Attach the power supply to the left side of the frame and plug the low-voltage connector to the termination marked J1 on lower center of the upper interconnect board.

*Mounting*

Mount the interior in the tub and secure it to the studs with the hardware supplied. Make sure that all line- and low-voltage wiring is confined to the appropriate areas.

*Low-Voltage Wiring*

Wire switches, sensors and other low-voltage control devices as shown in the Typical Wiring diagrams on the next two pages, using the 3/16" female push-on connectors installed on all leads.

*Line-Voltage Wiring*

Wire the relay SPST output terminals to the loads. Before making connections to the relay, however, make sure that none of the load circuits are shorted or miswired. Wire the power supply.

*Power Up the Power Supply and Test the Relays*

Apply power to the power supply only. Using a low-voltage jumper attached to any WHITE terminal, touch all of the switch input RED terminals, and then repeat for the BLACK terminals. The relays should "click" ON, then OFF. Confirm by measuring the line-voltage terminations of the relay. Test the operation of each low-voltage switch, sensor and other control device per the installation documentation accompanying the devices.

*Document Wiring*

Record the circuits controlled by each relay on the enclosed Wiring Schedule and then place in the plastic envelope attached to the inside of the panel cover.

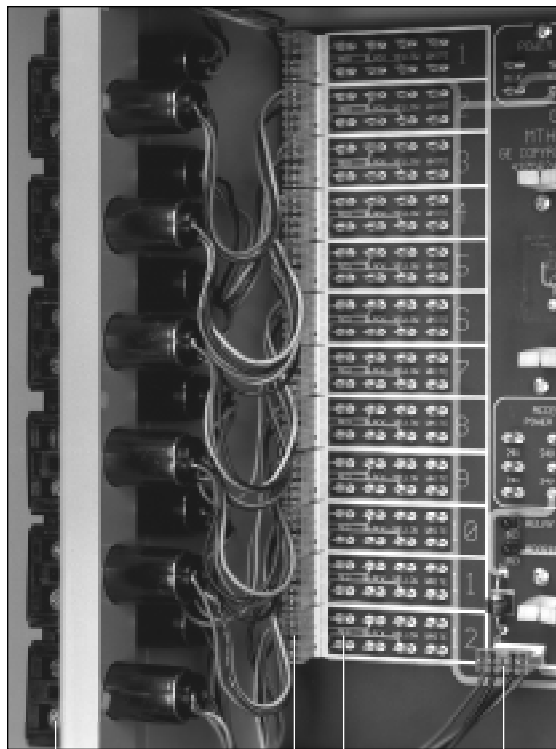

RELAY SPST LINE-VOLTAGE TERMINALS	POWER SUPPLY CONNECTOR AND J1 TERMINAL
LOW-VOLTAGE RELAY CONNECTORS	TERMINALS FOR SWITCHES, SENSORS AND OTHER LOW-VOLTAGE CONTROL DEVICES

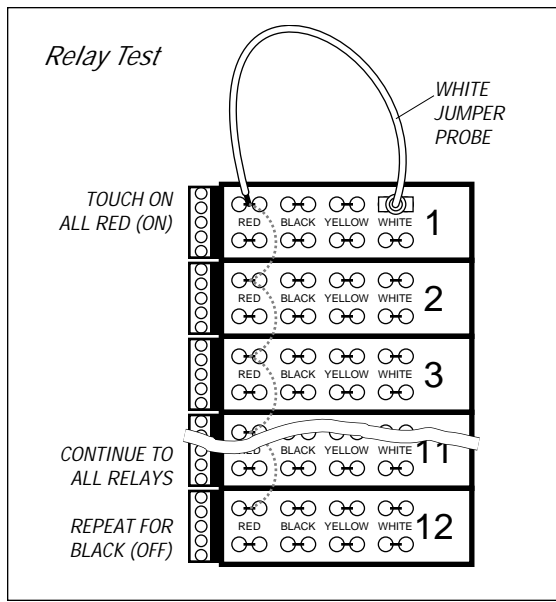

**INSTALLATION**

*Typical Wiring — Low-Voltage Switches*

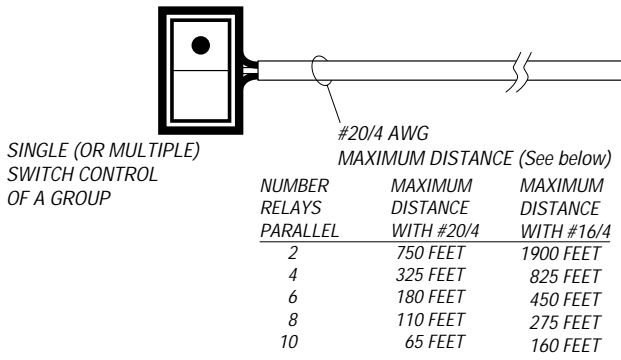
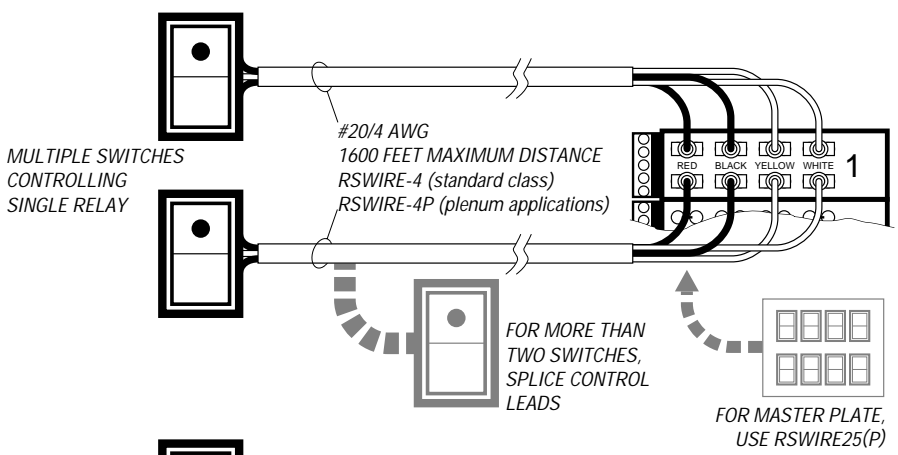
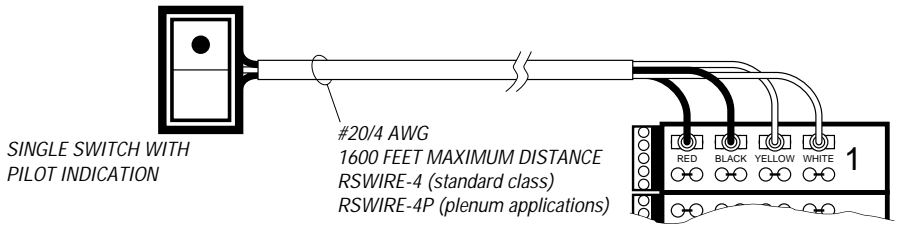
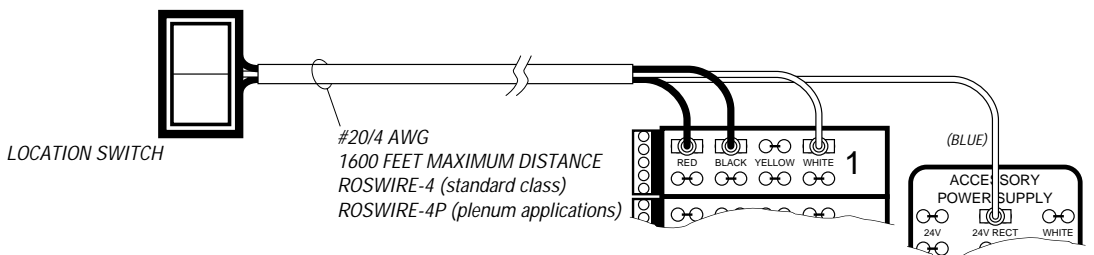
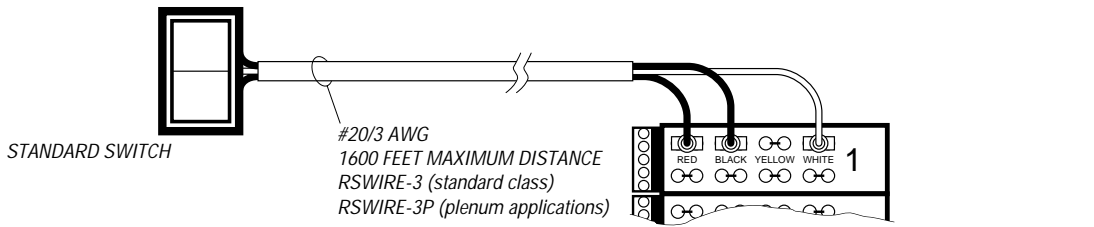

Note: Relays 1, 2 and 3 are now permanently wired as a group. You can't control them individually. If the pilot contacts are wired in parallel as above, turning ON any relay in the group will cause the pilot to light.

