

S4 Open: OPC-N2 Router Product Capabilities

The S4 Open: OPC-N2 Router offers flexibility and cost savings when integrating legacy Metasys® N2 networks to Open Systems. The OPC-N2 Router avoids costly replacement or re-engineering of existing devices on legacy N2 buses.

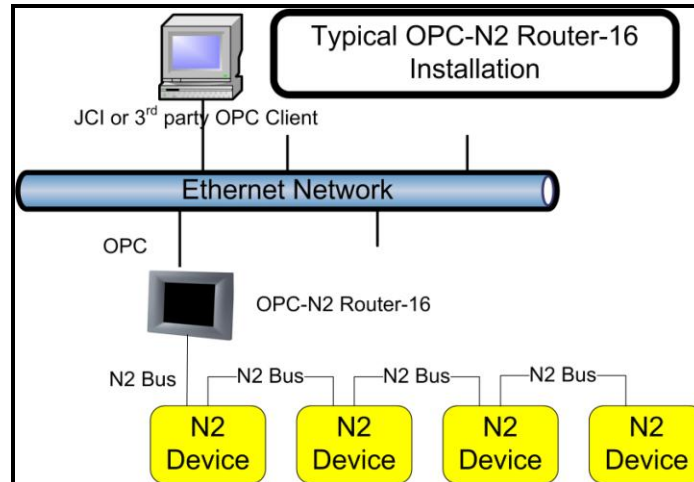

Typical Applications would be to bring data from the Metasys® N2 network into OPC-based enterprise applications, energy management applications, or adding best-of-breed OPC-based head end systems and HMIs from Johnson Controls or 3rd parties to legacy Metasys® installations.

The OPC-N2 Router automatically discovers all N2 devices on each Downstream N2 Network and publishes the devices, and their associated points, onto the Upstream N2 and OPC IP interfaces.

The S4 Open Console provides the user interface for all S4 Open appliances installed in a facility. Appliance discovery, setup, commissioning, maintenance, and

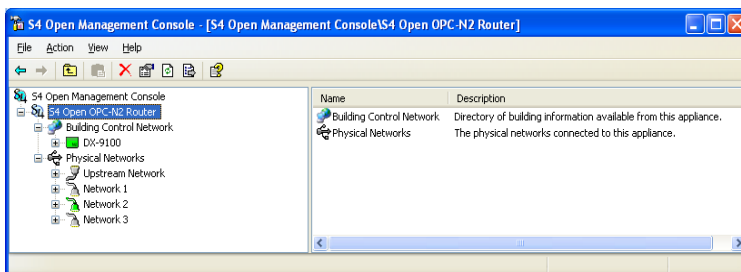

management are performed from this one convenient interface. Multiple copies of the S4 Open Console may be installed to manage your facility the way that works



S4 Open: OPC-N2 Router





Product Capabilities

most effectively for your organization.

Key S4 Open: OPC-N2 Router Features:

- Delivered as a turnkey network appliance, hosted on an Industrial PC
- Standard vendor tools are used to configure N2 devices on each N2 bus.
- All Metasys® N2 devices are supported including N2 Open, System-91, VMA, Facility Explorer, and 3rd party Metasys® Compatible devices.
- The S4 Open: Console eliminates typical DCOM and OPC security configuration headaches.
- Every N2 point is fully accessible, supporting read, write, override, and release operations as defined by the N2 device.
- Easily upgradeable via protocol and application plug-ins for expanded functionality.

The following models of the S4 Open: OPC-N2 Router available:

MODEL	N2 DEVICES	UPSTREAM N2 PORT	DOWNSTREAM N2 PORTS	HOST
OPC-N2 Router-16	16	No	1	
OPC-N2 Router-32	32	No	1	
OPC-N2 Router-64	64	No	1	
OPC-N2 Router-128	128	No	1	
OPC-N2 Router-256	253 (Note 2)	Yes (Note 1)	1 (Expandable)	

Note 1: Utilizing the Upstream N2 port allows you keep legacy Metasys supervisory controllers® in place.

Note 2: Johnson Controls reserves N2 addresses 0, 254, and 255.

The S4 Group's S4 Open line of Metasys® compatible products extend and enhance the capabilities and useful life of existing Metasys® installations. Contact The S4 Group, one of our channel partners, or visit our web site at www.TheS4Group.com for more information.



The S4 Group is a member of the Microsoft Windows Embedded Partners Program. All S4 Open appliances are powered by the Windows Embedded Operating System. Microsoft, Windows, and the Windows CE are registered trademarks of Microsoft Corporation in the United States and/or other countries